

PLANTA BAIXA

TANQUE SÉPTICO
3 M DE PROFUNDIDADE

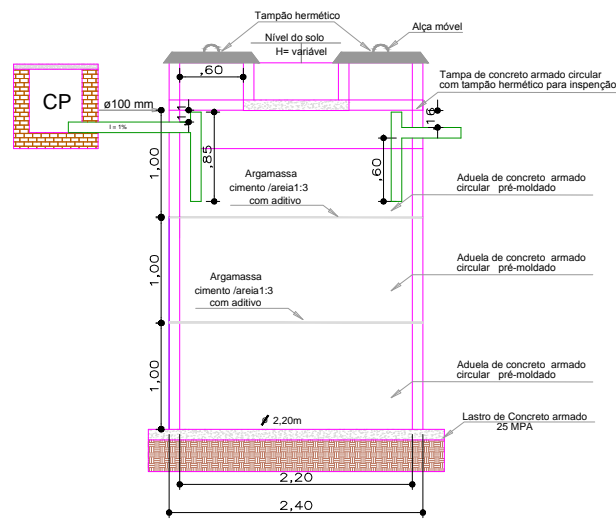

CORTE TANQUE SÉPTICO

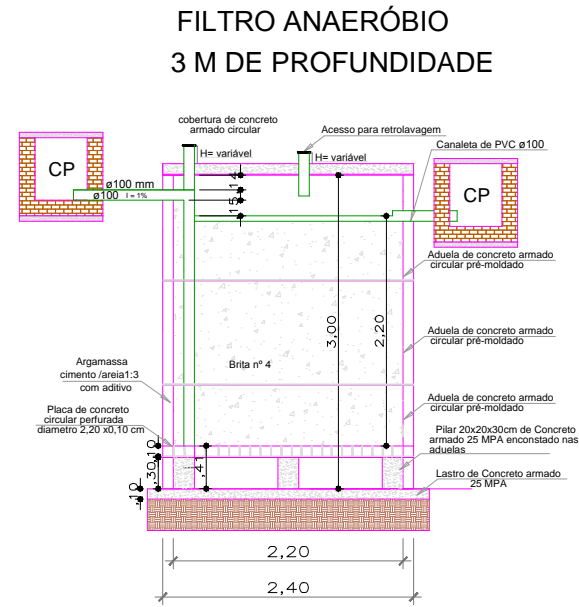

CORTE FITRO ANAERÓBIO

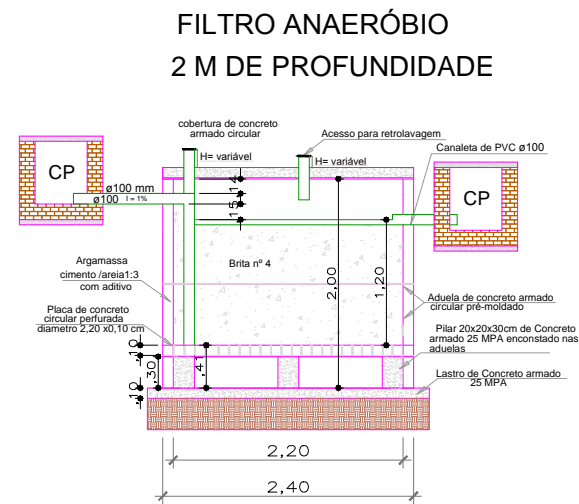

CORTE FITRO ANAERÓBIO

CAIXA DE INSPEÇÃO DE ESGOTO - 60x60 cm

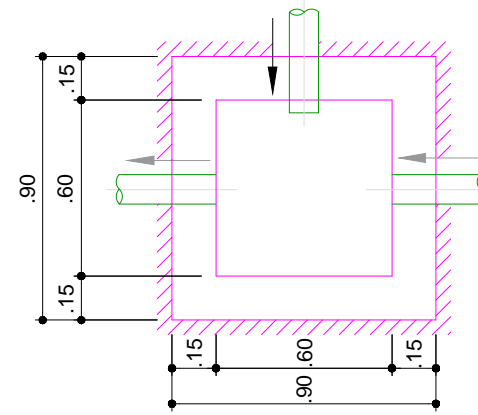

PLANTA BAIXA
SEM ESCALA

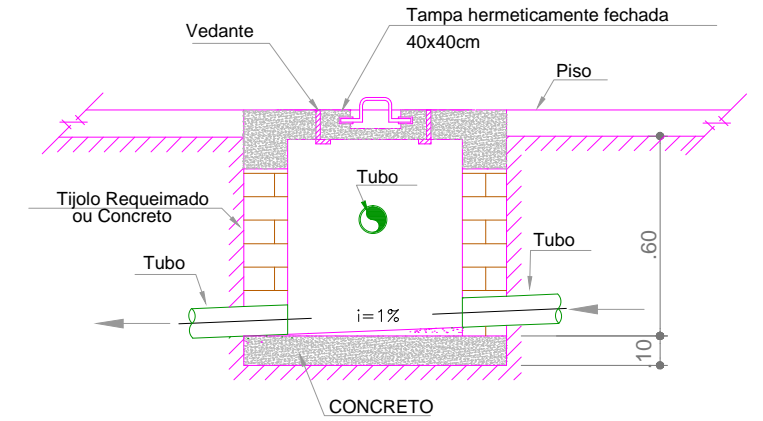

CORTE
SEM ESCALA

CAIXA DE GORDURA - 80x80 cm

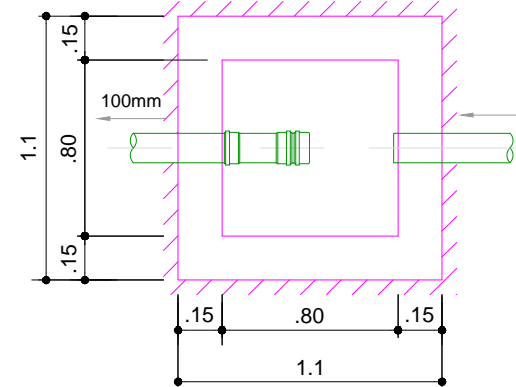

PLANTA BAIXA
SEM ESCALA

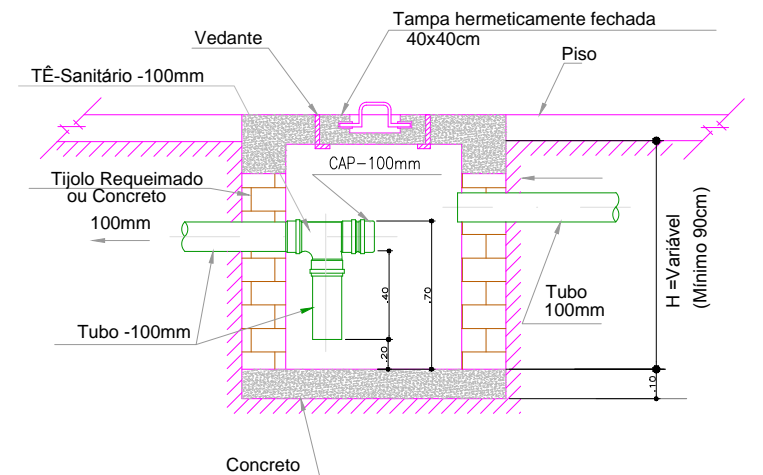

CORTE
SEM ESCALA



PREFEITURA MUNICIPAL DE
VÁRZEA GRANDE

PREFEITURA MUNICIPAL DE VÁRZEA GRANDE

Av. Castelo Branco, Espaço Municipal, 2500 - Centro Sul, Várzea Grande/MT

CEP 78125-700 - Fone/Fax: 65 3688 8000

PROJETO:
SISTEMA DE TRATAMENTO DE ESGOTO
EMEB EURENICE CESAR DE MELO

ASSUNTO:
DETALHAMENTO

DATA:
22/08/2016

UNIDADE:
METRO

ESCALA:
SEM

LOCALIZAÇÃO:

RUA JOAQUIM TAVARES, S/N - BAIRRO PIRINEU

RESPONSÁVEL TÉCNICO

VINÍCIUS JOSÉ CORRÊA DE MAGALHÃES
ENGENHEIRO CIVIL
CREA-MT 034715

RESP. TÉCNICO: LICENCIAMENTO AMBIENTAL

DYONI TOSHIO TRETTEL HATAQUEIAMA
ENG. SANITARISTA AMBIENTAL
CREA-MT 030979

FOLHA:

3/3